

xspecter

5 YEARS
WARRANTY

UGR<16

DALI



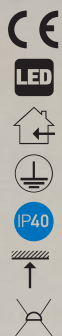

EN

Luminaires for suspended mounting, direct/indirect light flux distribution, equipped with SMD LEDs. Structure of aluminum profile, electrostatically painted with sandblasted finishing.

Suspension system with two twisted steel wires, maximum length of 1,5m with micrometric adjustment, ceiling and luminaire fixing elements.

Diffusers of transparent polycarbonate for indirect light. Diffuser of prismatic polystyrene for direct light.

Light guiding plate with screen printed grid of PMMA. Constant current driver included in the housing of the luminaire.

Power supply suspension cable 2P+N (3x0,75 mm²) with a maximum length of 2m.

Box for electrical connections in die-cast aluminum, with ceiling fixing system and self-locking 2P+N connection clamp, electrostatically painted with sandblasted finishing.

On request, the lighting fixture can be equipped with a dimmable DALI driver.

In this case, the power supply cable has to be changed to 2P+N (3x0,75 mm²) + 2P (2x0,75 mm²), the control circuit.

Range of applications

General interior lighting in offices, residential and recreational areas.

RO

Corpuri de iluminat cu montaj suspendat, distribuție directă/indirectă a fluxului luminos, echipate cu LED-uri SMD.

Structură din profil de aluminiu vopsită în câmp electrostatic cu finisaj sablat.

Sistem de suspendare cu două fire torsadate din oțel, lungimea maximă 1,5m, cu reglaj micrometric și elemente de fixare pentru tavan și corp.

Dispersoare din policarbonat transparent pentru iluminatul indirect.

Dispersor prismatic din polistiren pentru iluminatul direct.

Placă de ghidare a luminii, serigrafată, din PMMA.

Alimentator în curent constant inclus în carcasa corpului de iluminat.

Cablu de alimentare suspendat 2P+N (3x0,75 mm²) cu lungimea maximă de 2m.

Casetă pentru conexiunile electrice din aluminiu turnat cu sistem de fixare pe tavan și clemă de conexiuni 2P+N cu autoblocare, vopsită în câmp electrostatic, finisaj sablat.

La cerere corpul de iluminat poate fi echipat cu alimentator dimabil DALI.

În acest caz se schimbă și cablul de alimentare în 2P+N (3x0,75 mm²) + 2P (2x0,75 mm²), circuitul de control.

Aplicații

Iluminatul general de interior în birouri, zone rezidențiale și zone de agrement.

IT

Apparecchi per montaggio a sospensione, distribuzione del flusso luminoso diretta/indiretta, equipaggiati con LED SMD.

Struttura in alluminio estruso, verniciata a polveri con finitura sabbiata.

Sistema di sospensione con due fili di acciaio intrecciati, lunghezza massima 1,5m, con regolazione micrometrica ed elementi di fissaggio su soffitto e sul corpo.

Diffusori in policarbonato trasparente per luce indiretta. Diffusore in polistirene prismatico per luce diretta.

Piastra guida di luce con griglia serigrafata in PMMA. Alimentatore in corrente costante incluso in corpo di apparecchio.

Cavo di alimentazione a sospeso 2P+N (3x0,5 mm²) con lunghezza massima di 2m.

Scatola per connessioni elettriche in alluminio pressofuso, con sistema di fissaggio a soffitto e morsetto di connessione 2P+N autobloccante, verniciata a polveri finitura sabbiata.

Su richiesta l'apparecchio può essere dotato con alimentatore dimmerabile DALI.

In questo caso il cavo di alimentazione deve essere cambiato in 2P+N (3x0,75 mm²) + 2P (2x0,75 mm²), circuito di controllo.

Campi di applicazione

Illuminazione generale per interni in uffici, aree residenziali e ricreative.



MICROPRISMATIC DIFFUSER



see also:
xspecter floor
at page 230
xspecter wall
at page 256

xspecter

SPC02

FINISHING AVAILABLE

SWH SBK

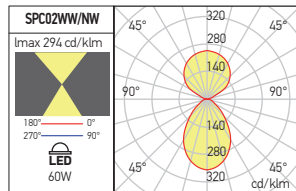
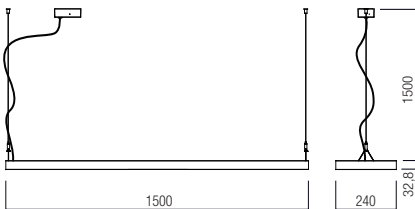
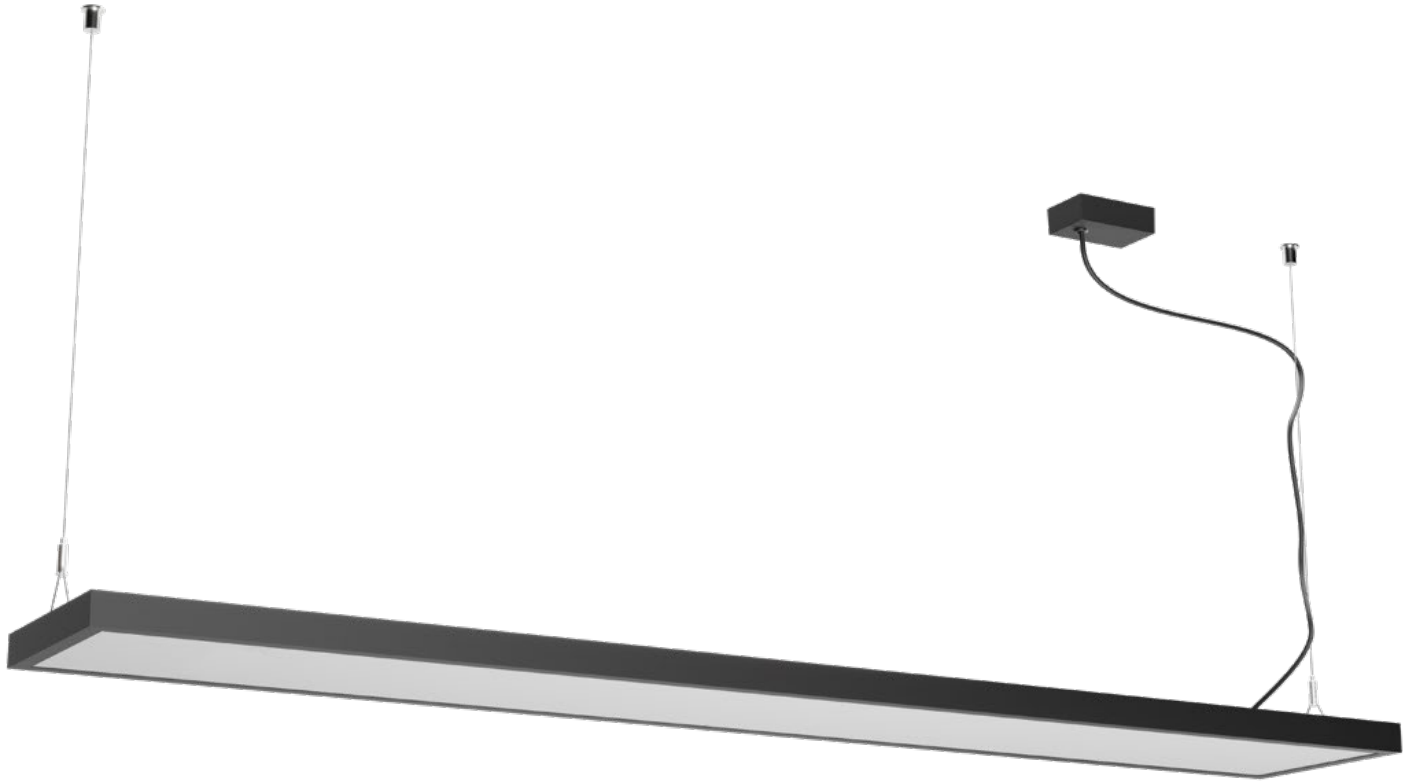

Code	Finishing	LED type	Power	Input voltage	Output current/voltage driver	Driver	LED flux	System flux	CCT	CRI	Optics	Weight
SPC02WW SWH	SWH	SMD 2835 Seoul Semiconductor	60W, 24 up 36 down	200-240V AC	1500 mA / 37V DC	Included	7800 lm 3550 up / 4250 down	5427 lm 2469 up / 2958 down	3000K	>90	115° up 80° down	5,60 kg
SPC02WW SBK	SBK	SMD 2835 Seoul Semiconductor	60W, 24 up 36 down	200-240V AC	1500 mA / 37V DC	Included	7800 lm 3550 up / 4250 down	5427 lm 2469 up / 2958 down	3000K	>90	115° up 80° down	5,60 kg
SPC02NW SWH	SWH	SMD 2835 Seoul Semiconductor	60W, 24 up 36 down	200-240V AC	1500 mA / 37V DC	Included	8125 lm 3680 up / 4445 down	5628 lm 2561 up / 3067 down	4000K	>90	115° up 80° down	5,60 kg
SPC02NW SBK	SBK	SMD 2835 Seoul Semiconductor	60W, 24 up 36 down	200-240V AC	1500 mA / 37V DC	Included	8125 lm 3680 up / 4445 down	5628 lm 2561 up / 3067 down	4000K	>90	115° up 80° down	5,60 kg

ARELUX 2024

ACCESSORY

FINISHING AVAILABLE

SWH SBK

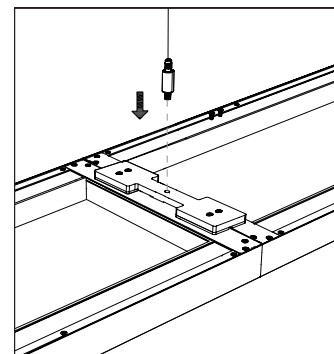
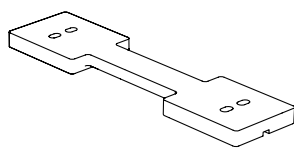

Code	Finishing	Weight
SPC02LC SWH	SWH	0,25 kg
SPC02LC SBK	SBK	0,25 kg

Accessory for making only the linear mechanical connection between two XSPECTER suspended lighting fixtures, SPC02WW/NW.
 Element of die-cast aluminum, electrostatically painted in sandblasted, with two rows of screws for fixing in the housings of the luminaires.
 Accesoriu pentru realizarea conexiunii doar mecanice liniare între două corpuri de iluminat suspendate XSPECTER, SPC02WW/NW.
 Corpul din aluminiu turnat vopsit în câmp electrostatic, culoare sablată, cu două rânduri de șuruburi pentru fixare în carcasele corpurilor de iluminat.
 Accessorio per realizzare il collegamento meccanico lineare tra due apparecchi a sospensione XSPECTER, SPC02WW/NW.
 Elemento in alluminio pressofuso, verniciato a polveri, sabbiato, con due file di viti per il fissaggio sui corpi degli apparecchi.



xspecter

5 YEARS
WARRANTY



EN

Luminaires for wall mounting, direct/indirect light flux distribution, equipped with SMD LEDs.
Structure and wall fixing system of aluminum profile, electrostatically painted with sandblasted finishing.
Diffusers of opal polycarbonate for indirect light.
Diffuser of prismatic polystyrene for direct light.
Light guiding plate with screen printed grid of PMMA.
Constant current driver included in the housing of the fixing system.
Self-locking block of terminals 2P+N (10A/250V/2,5 mm²).

Range of applications

General interior lighting in offices, residential and recreational areas.

RO

Corpur de iluminat tip aplică, distribuție directă/indirectă a fluxului luminos, echipate cu LED-uri SMD.
Structură și sistem de fixare pe perete din profil de aluminiu vopsite în câmp electrostatic cu finisaj sablat.
Dispersoare din policarbonat transparent pentru iluminatul indirect.
Dispersor prismatic din polistiren pentru iluminatul direct.
Placă de ghidare a luminii, serigrafată, din PMMA.
Alimentator în curent constant inclus în carcasa sistemului de fixare.
Clemă de conexiuni cu autoblocare 2P+N (10A/250V/2,5 mm²).

Aplicații

Iluminatul general de interior în birouri, zone rezidențiale și zone de agrement.

IT

Apparecchi per montaggio a parete, distribuzione del flusso luminoso diretta/indiretta, equipaggiati con LED SMD.
Struttura e sistema di fissaggio in alluminio estruso, verniciati a polveri con finitura sabbata.
Diffusori in policarbonato trasparente per luce indiretta.
Diffusore in polistirene prismatico per luce diretta.
Piastra guida di luce con griglia serigrafata in PMMA.
Alimentatore in corrente costante incluso in corpo di sistemi di fissaggio.
Morsetteria autobloccante 2P+N (10A/250V/2,5 mm²).

Campi di applicazione

Illuminazione generale per interni in uffici, aree residenziali e ricreative.

SPC03

FINISHING AVAILABLE

SWH

SBK

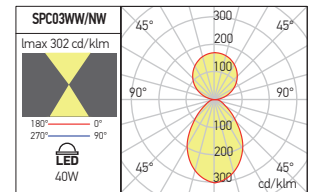
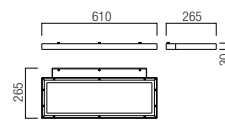

Code	Finishing	LED type	Power	Input voltage	Output current/voltage driver	Driver	LED flux	System flux	CCT	CRI	Optics	Weight
SPC03WW SWH	SWH	SMD 2835 SEOUL Semiconductor	40W 20W up, 20W down	200-240V AC	1050 mA / 35V DC	Included	5184 lm 2680 up, 2504 down	3305 lm 1709 up, 1596 down	3000K	>90	90° up 80° down	3,20 kg
SPC03WW SBK	SBK	SMD 2835 SEOUL Semiconductor	40W 20W up, 20W down	200-240V AC	1050 mA / 35V DC	Included	5184 lm 2680 up, 2504 down	3305 lm 1709 up, 1596 down	3000K	>90	90° up 80° down	3,20 kg
SPC03NW SWH	SWH	SMD 2835 SEOUL Semiconductor	40W 20W up, 20W down	200-240V AC	1050 mA / 35V DC	Included	5386 lm 2780 up, 2606 down	3427 lm 1772 up, 1655 down	4000K	>90	90° up 80° down	3,20 kg
SPC03NW SBK	SBK	SMD 2835 SEOUL Semiconductor	40W 20W up, 20W down	200-240V AC	1050 mA / 35V DC	Included	5386 lm 2780 up, 2606 down	3427 lm 1772 up, 1655 down	4000K	>90	90° up 80° down	3,20 kg



see also:
xspecter suspension
at page 252

xspecter floor
at page 230